

EUROSTAGE

MOBILE STAGES

16+ Decks

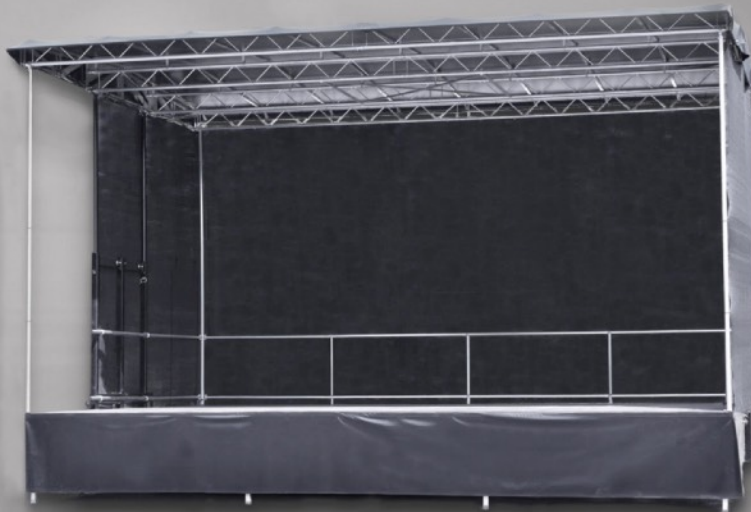
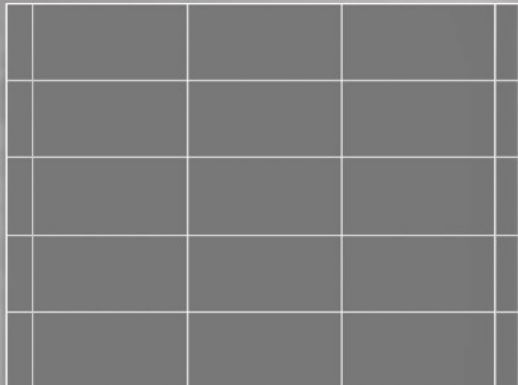

ES-2620

EuroStage Mobile Stages

The easiest, lightest, quickest, and most affordable professional stage on the market. All with **Clark Reder Engineering** design and safety certifications for all 50 states..

Our series of mobile stages are custom designed, engineered, and built for the US market. This modern design was achieved by targeting certain elements of older stage concepts that simply add cost and weight instead of function and value.

By strategically reducing these older design components and concepts, we've created a stage tailored for small to mid-sized staging and sound companies at a cost and ROI that will revolutionize the US mobile stage market.

4 Stage Models: ES-3322 | **ES-2620** | ES-2016 | ES-1612

**Stop Renting.
Own Your Own Mobile Stage.**

For more information contact us at:

info@EuroStage.us

www.EuroStage.us

www.Facebook.com/EuroStageMobileStages

www.Instagram.com/EuroStageMobileStages



PRELIMINARY SPECS

Trailer Specs:

Weight: 5,075 lbs.
Tongue Weight: 550 lbs.
Length: 32'-6"
Width: 7'-10"
Height: 11'-9"
Axels: (2) 3,500 lbs. ea.
Towing: Bumper w/ 2" ball

Stage Deck Specs:

Width: 26'-3"
Depth: 19'-9"
Area: 518 sf.
Load: 25,900 lbs. / 50 lbs. sf.
Deck Height: 3' to 4'-3"

Roof Specs:

Width: 26'-10"
Depth: 21'-11"
Deck to Truss: 13'-3"
Area: 590 sf.
Total Height: 18' to 19'-3"

Capacity Specs:

Front Truss: 825 lbs. UDL
Center Truss: (2) 825 lbs. UDL
Back Truss: 825-2,000 lbs. UDL
Fly Bay: 5' = 750 lbs. ea. CP
Fly Bay: 10' = 800 lbs. ea. UDL
Roof: 4,800+ lbs. UDL
Lifting Limit: 2,000 lbs. UDL

Wind Specs:

Clark Reder HWAP / 67 MPH

Hydraulics:

Single piston w/12v hydraulic pump

Set Up Time:

1 Tech + 1 Volunteer: 10-20 Mins.

EuroStage ES-2620 Mobile Stage

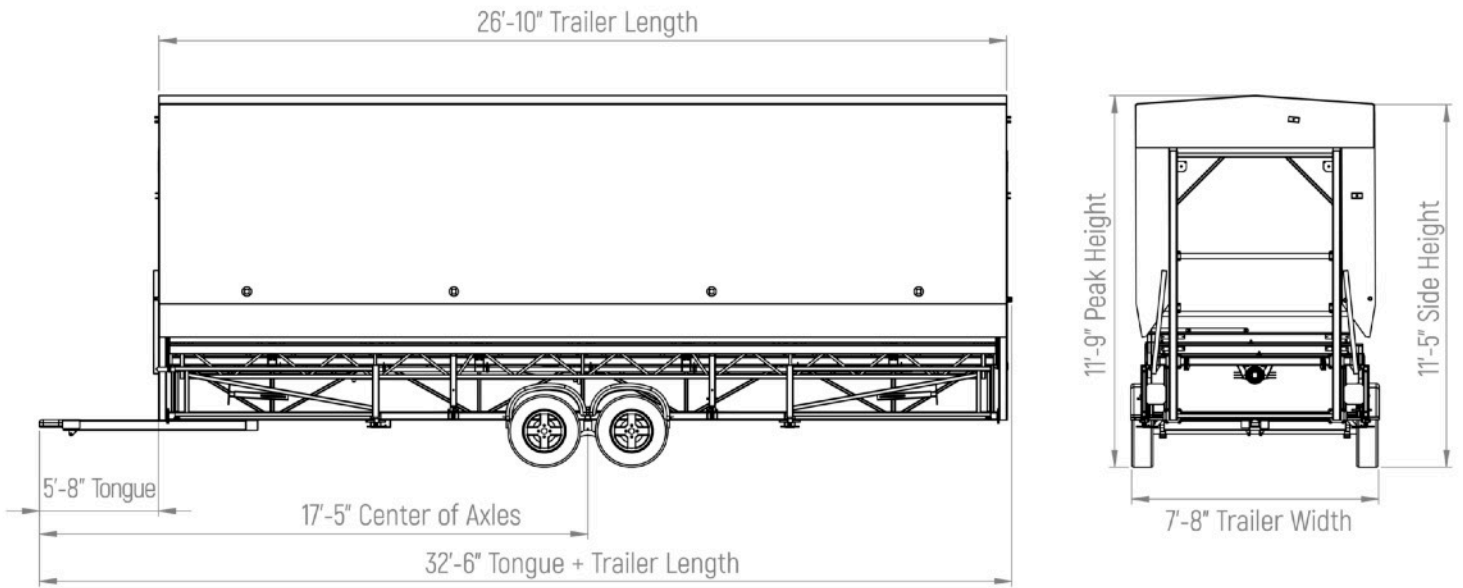

EuroStage ES-2620 Mobile Stage (Side)

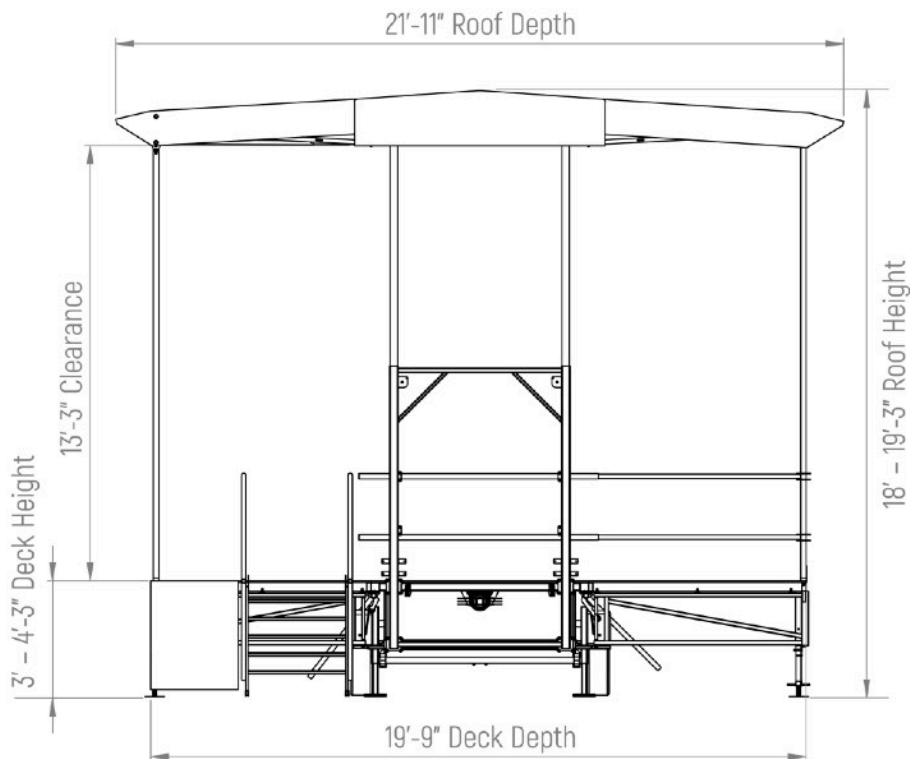

EuroStage ES-2620 Mobile Stage

(Front)

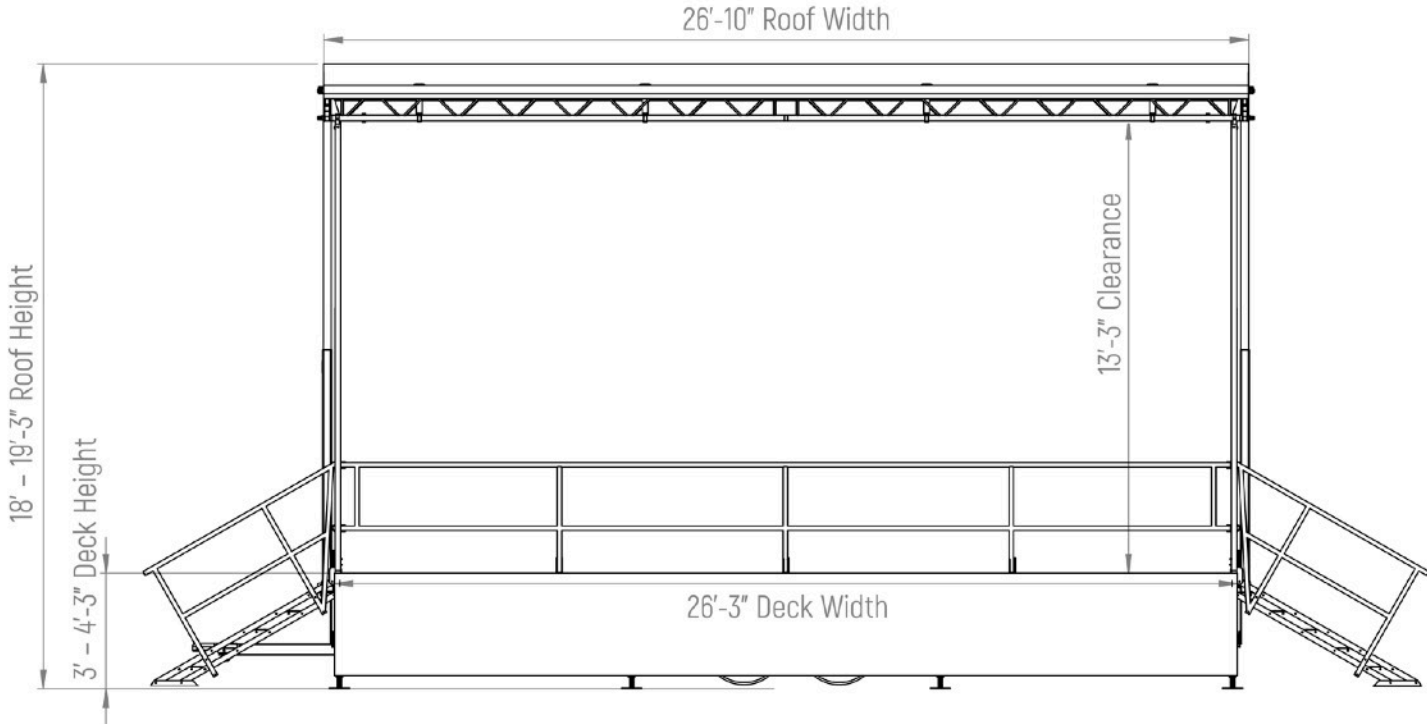

EuroStage ES-2620 Mobile Stage

(Front + 5' Fly Bays)

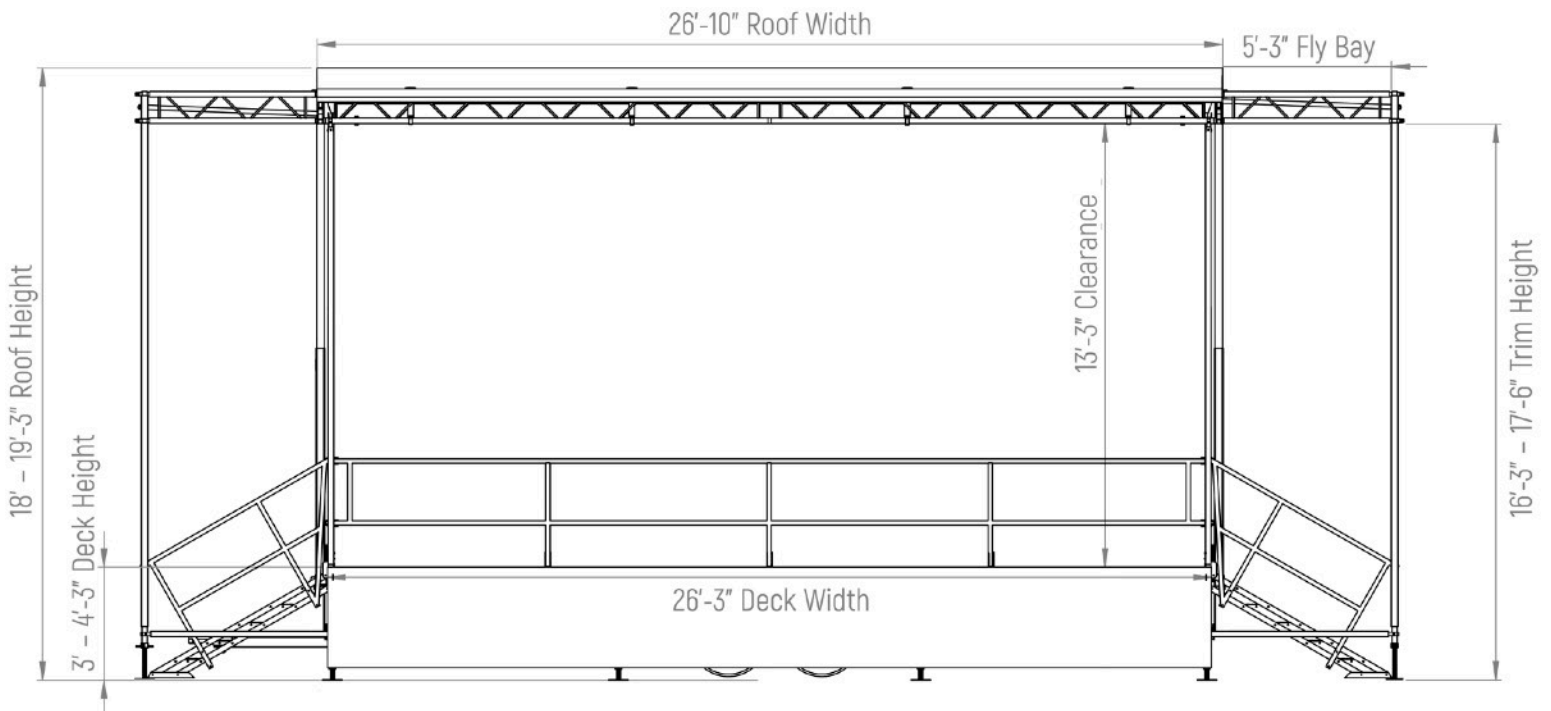

EuroStage ES-2620 Mobile Stage

(Front + 10' Fly Bays + LED Wall Support)

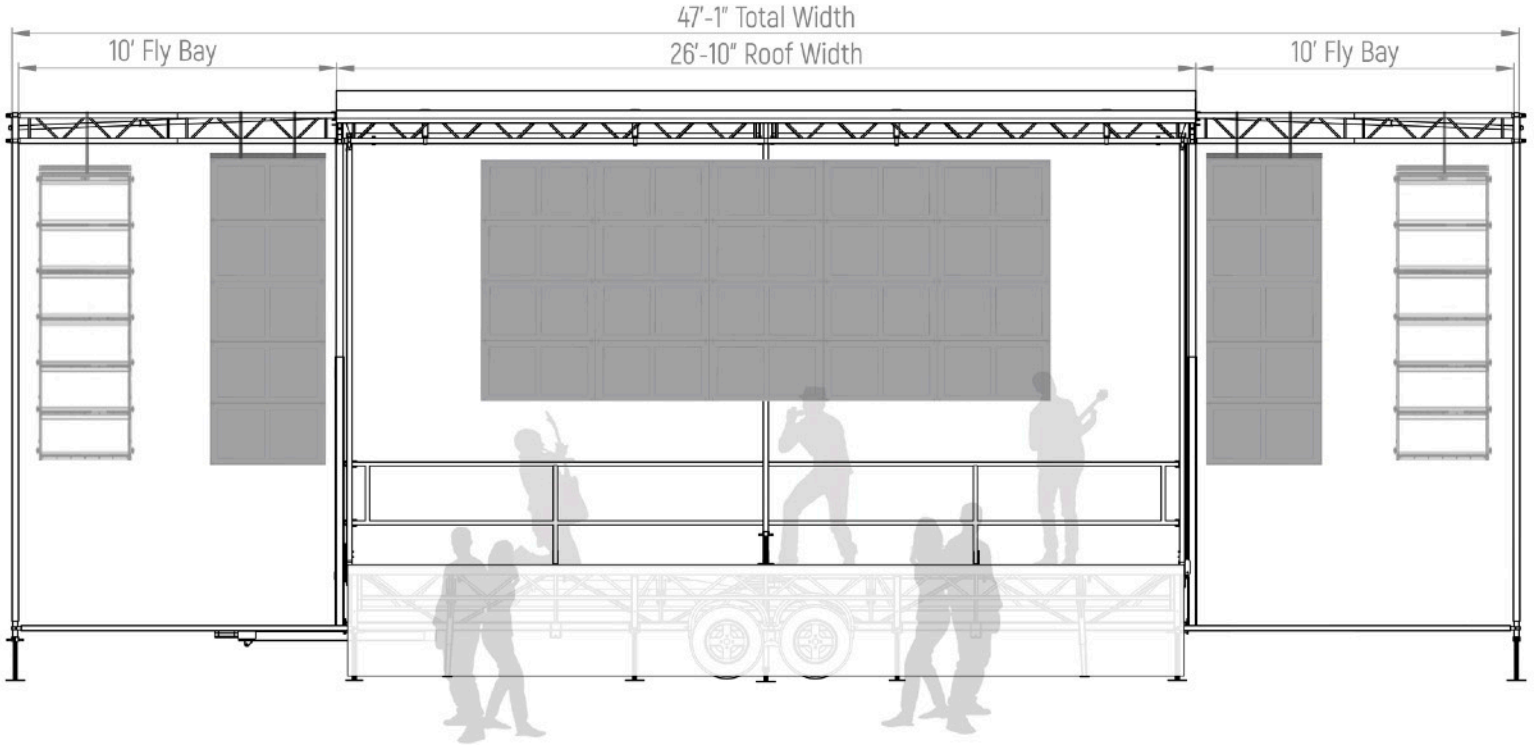

EuroStage ES-2620 Mobile Stage

(3pc Wind Wall Kit + Banner Kit)

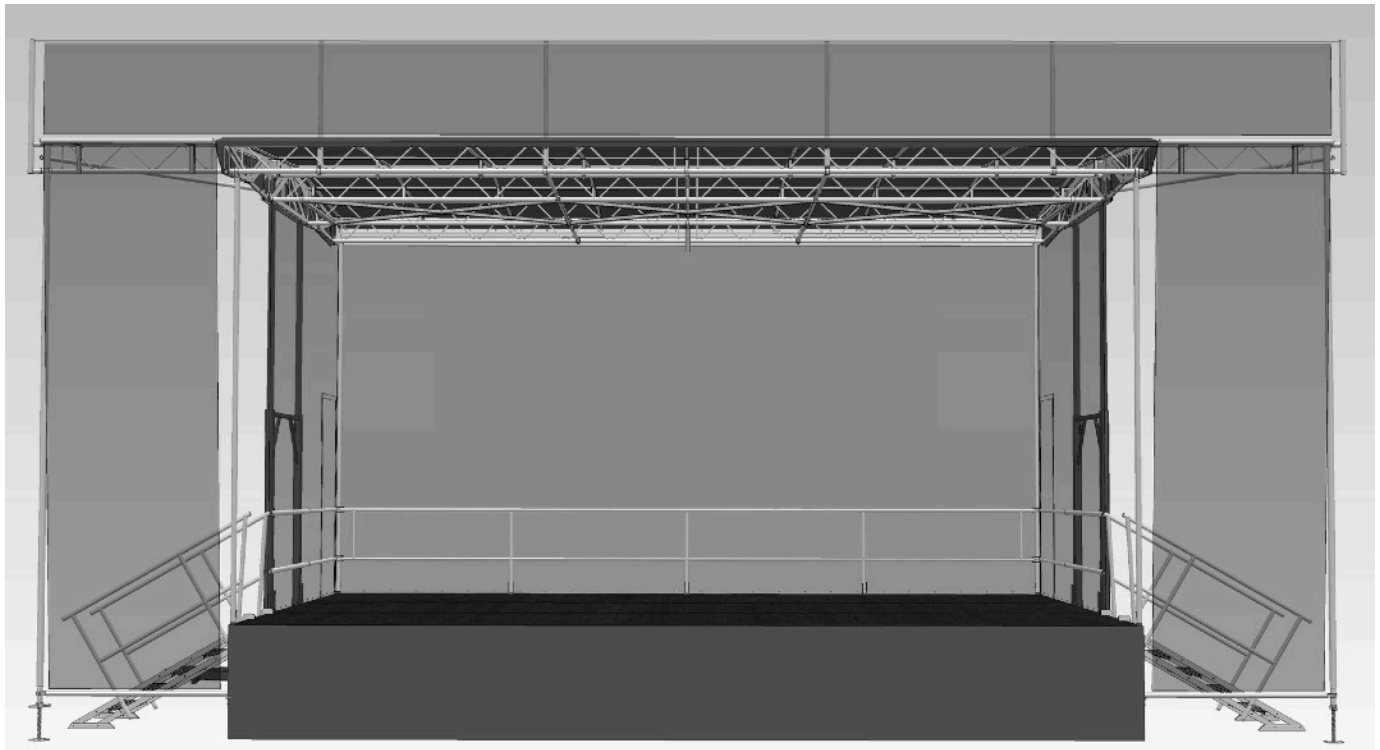

37' x 3' Top Banner / 5' x 15' Side Banners

EuroStage ES-2620 Mobile Stage

(Stage Decks)

